

PROJECT	_____
TYPE	_____
SPECIFIER	_____
QUANTITY	_____
DATE	_____

CALIBER 120 D RECESSED

E12I0036-

base number Color Finish Lens
 Temperature Options Options

- To build a product code in our configurator select the specify button on the base model # product page
- To build a manual product code on this datasheet choose from the options listed below in blue font and add the suffix to the base model #

GENERAL

Series: Caliber
 Subseries: Caliber 120 D
 Brand: Unonovesette
 Division: Exterior
 Mounting Type: Recessed
 Mounting Location: In-Ground
 Subcategory: Drive Over

PHYSICAL

Shape: Square
 Diameter (mm): 116
 Diameter (in): 4 5/16
 Height (mm): 104
 Height (in): 4 1/8
 Light Distribution: Direct
 Weight (kg): 0.900
 Weight (lbs): 1.98
 Installation Requirement: Housing box
 Diffuser: Extra clear glass 6mm
 Fixture Finish: ASB / SST
 Fixture Material: Stainless Steel AISI 316L
 Cable Details: 350mm NS20N PCP 2x0.5 mm2

ELECTRICAL

Lamp Type: LED
 Input Wattage (W): 8.1
 Total Output Wattage (W): 5
 Dimming: Non-Dimming / Phase Dimming (120Vac only) / 0-10V Dimming
 Driver Included: No
 Driver Location: Remote
 Driver Type: Constant Voltage - Universal
 Driver Class: Class 2
 Input Voltage (V): 120 - 277
 Output Voltage (V): 24

LED

Number of LEDs: 1
 Color Temperature (°K): 2700 / 3000 / 4000
 Max. Delivered Lumen (lm): 515
 CRI: >90 CRI
 Lamp Life (hrs): 100000

OPTICAL

Optic°: 10 / 35 / 50
 Beam Angle: Narrow / Medium / Wide
 Adjustability: Rotational 360°; Tilt 15°

RATINGS AND CERTIFICATIONS

Certified By: Certified for North American Standards
 IP rating: IP68 (not for permanent immersion)
 IK Rating: IK08
 Marine Grade: Stainless Steel AISI 316L



CALIBER 120 D RECESSED

E12I0036-

PROJECT

TYPE

SPECIFIER

QUANTITY

DATE



E

CALIBER 120 D RECESSED

E1210037- - -

base number Color Finish Lens
 Temperature Options Options

- To build a product code in our configurator select the specify button on the base model # product page
- To build a manual product code on this datasheet choose from the options listed below in blue font and add the suffix to the base model #

GENERAL

Series: Caliber
 Subseries: Caliber 120 D
 Brand: Unonovesette
 Division: Exterior
 Mounting Type: Recessed
 Mounting Location: In-Ground
 Subcategory: Drive Over

PHYSICAL

Shape: Square
 Diameter (mm): 116
 Diameter (in): 4 ⁹/₁₆
 Height (mm): 104
 Height (in): 4 ¹/₈
 Light Distribution: Direct
 Weight (kg): 0.900
 Weight (lbs): 1.98
 Installation Requirement: Housing box
 Diffuser: Extra clear glass 6mm
 Fixture Finish: [ASB / SST](#)
 Fixture Material: Stainless Steel AISI 316L
 Cable Details: 350mm NS20N PCP 2x0.5 mm2

ELECTRICAL

Lamp Type: LED
 Input Wattage (W): 9.04
 Total Output Wattage (W): 8.5
 Dimming: Non-Dimming / Phase Dimming (120Vac only) / 0-10V Dimming
 Driver Included: No
 Driver Location: Remote
 Driver Type: Constant Voltage - Universal
 Driver Class: Class 2
 Input Voltage (V): 120 - 277
 Output Voltage (V): 24

LED

Number of LEDs: 1
 Color Temperature (°K): [2700 / 3000 / 4000](#)
 Max. Delivered Lumen (lm): 730 (3000K)
 CRI: >90 CRI
 Lamp Life (hrs): 100000

OPTICAL

Optic°: [10 / 35 / 50](#)
 Beam Angle: Narrow / Medium / Wide
 Adjustability: Rotational 360°; Tilt 15°

RATINGS AND CERTIFICATIONS

Certified By: Certified for North American Standards
 IP rating: IP68 (not for permanent immersion)
 IK Rating: IK08
 Marine Grade: Stainless Steel AISI 316L

PROJECT
TYPE
SPECIFIER
QUANTITY
DATE



Ø116mm 4 ⁹/₁₆"

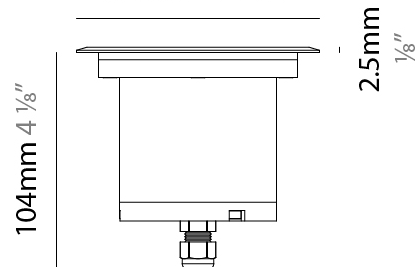

CALIBER 120 D RECESSED

E12I0037-

PROJECT

TYPE

SPECIFIER

QUANTITY

DATE



E

CALIBER 120 D RECESSED

E12I0039- -

base number Color Finish
 Temperature Options

PROJECT
TYPE
SPECIFIER
QUANTITY
DATE

- To build a product code in our configurator select the specify button on the base model # product page
- To build a manual product code on this datasheet choose from the options listed below in blue font and add the suffix to the base model #

GENERAL

Series: Caliber
 Subseries: Caliber 120 D
 Brand: Unonovesette
 Division: Exterior
 Mounting Type: Recessed
 Mounting Location: In-Ground
 Subcategory: Drive Over

PHYSICAL

Shape: Square
 Diameter (mm): 116
 Diameter (in): 4 5/16
 Height (mm): 104
 Height (in): 4 1/8
 Light Distribution: Direct
 Weight (kg): 0.900
 Weight (lbs): 1.98
 Installation Requirement: Housing box
 Diffuser: Extra clear glass 6mm
 Fixture Finish: [ASB / SST](#)
 Fixture Material: Stainless Steel AISI 316L
 Cable Details: 350mm NS20N PCP 2x0.5 mm2

ELECTRICAL

Lamp Type: LED
 Input Wattage (W): 10.4
 Total Output Wattage (W): 8.6
 Dimming: Non-Dimmable / 0-10V Dimming
 Driver Included: No
 Driver Location: Remote
 Driver Type: Constant Voltage - Universal
 Driver Class: Class 2
 Housing: ENCP8
 Input Voltage (V): 120 - 277
 Output Voltage (V): 24
 Constant Voltage (V): 24.06

LED

Number of LEDs: 1
 Color Temperature (°K): [RGBW](#)
 CRI: >90 CRI
 Lamp Life (hrs): 100000

OPTICAL

Optic°: 35
 Beam Angle: Medium
 Adjustability: Rotational 360°; Tilt 15°

RATINGS AND CERTIFICATIONS

Certified By: Certified for North American Standards
 IP rating: IP68 (not for permanent immersion)
 IK Rating: IK08
 Marine Grade: Stainless Steel AISI 316L

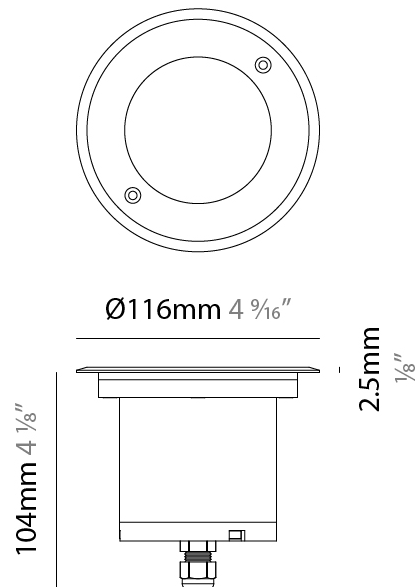

CALIBER 120 D RECESSED

E12I0039-

PROJECT

TYPE

SPECIFIER

QUANTITY

DATE



E

PROJECT

TYPE

SPECIFIER

QUANTITY

DATE

Fixture Finish

Machined aged solid brass - ASB



Stainless Steel - SST



Digital: Not all screens are calibrated the same, and therefore, colors will appear differently between screens.

Physical: When texture is involved, there will be variations in color, character and tone within a product series and between product families.













PROJECT
TYPE
SPECIFIER
QUANTITY
DATE

LEGEND

 floor-mounted	 pivotable	 special LED (upon request) RGB, RGBW, tunable, gold+, meat+, art+, fashion+
 wall and ceiling: recessed and surface mounted	 rotating	 warm dim / natural dimming LED
 ceiling-mounted and wall-mounted	 illuminate tilted	 rechargeable battery powered
 wall-mounted	 color of suspension cable	 fixture with natural vivid LED (upon request)
 omni-directional light distribution	 length of suspension cable	 color rendering index
 direct light distribution	 reflector degree selection	 color temperature
 direct/indirect light distribution	 super spot	 lumen (luminous flux)
 indirect light distribution	 lens	 efficacy (lumens per watt)
 asymmetric light distribution	 lens pack	 Unified Glare Rating (UGR) range from 5-40
 aura light distribution	 shine ring	 marine grade (AISI 316 stainless steel)
 round wall or ceiling cut-out	 integrated shine ring with diffuser	 walk on
 square wall or ceiling cut-out	 free individual colors 01-29	 drive on
 the supplied jig specifies the cutout dimensions	 individual colors: 00 (free of charge), 01-25 (extra charge)	 Dark Sky Compliance
 minimum distance (meters) lamp - object	 luminaire part to be colored (F1)	 Americans with Disabilities Act (less than 4" off the wall located between 27"-84" from floor)
 recessed depth	 luminaire part to be colored (F2)	 lamp protected against explosion
 ceiling thickness in mm	 luminaire part to be colored (F3)	 blown glass using traditional methods by master glass blower
 ceiling thickness selection	 luminaire part to be colored (F4)	 acoustic material
 dimmable DP (phase), DV (0-10V), DD (dali), DS (step-dim)	 luminaire part to be colored (F5)	 protection class I, protection insulation
 included or excluded LED driver/transformer/control gear	 color of 3-circuit adaptor	 protection class II, protection insulation
 separately switchable	 indirect diffuser	 ETL Certified to UL and CSA Standards
 sensor	 direct diffuser	 UL Certified to UL and CSA Standards
 remote control	 ball-proof (upon request)	 CSA Certified to UL and CSA Standards
 available upon request	 accessory	 Certified for North American Standards

IP RATING

 IP20	protected against ingress of solid bodies greater than 12.5mm (finger)
 IP33	protected against ingress of solid bodies greater than 2.5mm protected against sprays of water up to 60 degrees from the vertical (rain)
 IP40	protected against ingress of solid bodies greater than 1mm (wire) no protection against the ingress of moisture
 IP43	protected against ingress of solid bodies greater than 1mm (wire) protected against sprays of water up to 60 degrees from the vertical (rain)
 IP44	protected against ingress of solid bodies greater than 1mm (wire) protected against water splashed from all directions
 IP54	protected against limited ingress of dust (wet rooms/covered outdoor areas) protected against water splashed from all directions
 IP65	protected against ingress of dust protected against jets of water
 IP66	protected against ingress of dust protected against powerful jets of water or heavy seas
 IP67	protected against ingress of dust protected against immersion of water between 15cm - 1m for 30 minutes
 IP68	protected against ingress of dust protected against immersion of water under pressure for long periods

IK RATING

 IK01	protected against 0.14 joules impact (equivalent to 0.25kg mass dropped from 56mm above the surface)
 IK02	protected against 0.2 joules impact (equivalent to 0.25kg mass dropped from 80mm above the surface)
 IK03	protected against 0.35 joules impact (equivalent to 0.25kg mass dropped from 140mm above the surface)
 IK04	protected against 0.5 joules impact (equivalent to 0.25kg mass dropped from 200mm above the surface)
 IK05	protected against 0.7 joules impact (equivalent to 0.25kg mass dropped from 280mm above the surface)
 IK06	protected against 1 joules impact (equivalent to 0.25kg mass dropped from 400mm above the surface)
 IK07	protected against 2 joules impact (equivalent to 0.5kg mass dropped from 400mm above the surface)
 IK08	protected against 5 joules impact (equivalent to 1.7kg mass dropped from 300mm above the surface)
 IK09	protected against 10 joules impact (equivalent to 5.0kg mass dropped from 200mm above the surface)
 IK10	protected against 20 joules impact (equivalent to 5.0kg mass dropped from 400mm above the surface)